



JINN-YEH Industrial Co.,Ltd.

Tel : +886-4-881-5065 Fax : +886-4-8817065

E-mail 1: amoeba.tw@msa.hinet.net

E-mail 2: amoebabiketw@gmail.com

46, Lane 201, Sec.1 Ta-Shi Rd., Shi-Hu 514, Chang-Hua, Taiwan

HUB



E-Bike Hub



HU-EB754B-R(BOOST)

Pro 4 Flange PAT.

MTB/E-BIKES

Holes : 32/36 H

Axle : AL7075

O.L.D : M12-148mm

Bearing: 5 pcs

P.C.D : 62/57-61/56mm

Weight : 358 g

Shimano : Type 9/10/11/12 Speed

Optional: SRAM : XD / XDR



HU-EB754B-F(BOOST)

Pro 4 Flange PAT.

MTB/E-BIKES

Holes : 32/36 H

Axle : AL7075

O.L.D : M15-110mm

Bearing: 2 pcs

P.C.D : 62/57-61/56mm

Weight : 226 g

Optional: BOOST M20



HU-EB734B-R (BOOST)

Pro 4 Flange PAT.

MTB/E-BIKES

Holes : 32/36H

Axle : AL7075

O.L.D : M12-148mm

Bearing: 4 pcs

P.C.D : 62/57-61/56mm

Weight : 326 g

Shimano : Micro Spline

Color Option :



E-BIKE Hub

HU-EM824B-R (BOOST)

Pro 4 Flange PAT.

MTB/E-BIKE

Center Lock Disc Brake

Holes : 32/36 H

Axle : AL7075

O.L.D : M12-148 mm

Bearing: 5 pcs

P.C.D : 57/52-61/56 mm

Weight : 296 g

Shimano : Type 9/10/11/12 Speed

Optional: SRAM : XD / XDR



HU-EM824B-F(BOOST)

Pro 4 Flange PAT.

MTB/E-BIKE

Center Lock Disc Brake

Holes : 32/36 H

Axle : AL7075

O.L.D : M15-110 mm

Bearing: 2 pcs

P.C.D : 57/52-50/45 mm

Weight : 170 g



HU-EM864B-R(BOOST)

Pro 4 Flange PAT.

MTB/E-BIKE

Center Lock Disc Brake

Holes : 32/36 H

Axle : AL7075

O.L.D : M12-148 mm

Bearing: 4 pcs

P.C.D : 57/52-61/56 mm

Weight : 306 g

Shimano : Micro Spline 12 Speed



E-BIKE Hub



HU-EM728B-R (BOOST)

Pro 4 Flange PAT.

MTB/E-BIKE

Center Lock Disc Brake

Holes : 28/32 H

Axle : AL7075

O.L.D : M12-148 mm

Bearing: 5 pcs

P.C.D : 53/58 mm

Weight : 290 g

Shimano : Type 9/10/11/12 Speed

Optional: SRAM : XD / XDR



HU-EM728B-F(BOOST)

Pro 4 Flange PAT.

MTB/E-BIKE

Center Lock Disc Brake

Holes : 28/32 H

Axle : AL7075

O.L.D : M15-110 mm

Bearing: 2 pcs

P.C.D : 49/53 mm

Weight : 160 g



HU-EM723B-R(BOOST)

Pro 4 Flange PAT.

MTB/E-BIKE

Center Lock Disc Brake

Holes : 32/36 H

Axle : AL7075

O.L.D : M12-148 mm

Bearing: 4 pcs

P.C.D : 53/58 mm

Weight : 300 g

Shimano : Micro Spline 12 Speed

Color Option :



E-Bike Hub

HU-EB758B-R(BOOST)

MTB/E-BIKE

Holes : 32/36 H

Axle : AL7075

O.L.D : M12-148mm

Bearing: 5 pcs

P.C.D : 58/58mm

Weight : 308 g

Shimano : Type 9/10/11/12 Speed

Optional: SRAM : XD / XDR



HU-EB758B-F(BOOST)

MTB/E-BIKE

Holes : 32/36H

Axle : AL7075

O.L.D : M15-110mm

Bearing: 2 pcs

P.C.D : 58/58mm

Weight : 208g

Optional: BOOST M20



HU-EB753B-R(BOOST)

MTB/E-BIKE

Holes : 32/36 H

Axle : AL7075

O.L.D : M12-148mm

Bearing: 4 pcs

P.C.D : 58/58mm

Weight : 316 g

Shimano : Micro Spline



Color Option :



E-Bike Road Hub



HU-EGR824-R

Pro 4 Flange PAT.

E-BIKES RACING

Center Lock Disc Brake

Holes : 28/32 H

Axle : AL7075

O.L.D : M12-142mm

Bearing: 5 pcs

P.C.D : 57/52-61/56mm

Weight : 286g

Shimano : Type 9/10/11/12 Speed

Optional: SRAM : XD / XDR



HU-EGR824-F

Pro 4 Flange PAT.

E-BIKES RACING

Center Lock Disc Brake

Holes : 28/32 H

Axle : AL7075

O.L.D : M12-100mm

Bearing: 2 pcs

P.C.D : 57/52-50/45 mm

Weight : 158g



HU-EGR728-R

E-BIKES RACING

Center Lock Disc Brake

Holes : 28/32 H

Axle : AL7075

O.L.D : M12-142mm

Bearing: 4 pcs

P.C.D : 53/58mm

Weight : 276g

Shimano : Type 9/10/11/12 Speed

Optional: SRAM : XD / XDR



HU-EGR728-F

E-BIKES RACING

Center Lock Disc Brake

Holes : 28/32 H

Axle : AL7075

O.L.D : M12-100mm

Bearing: 2 pcs

P.C.D : 49/53mm

Weight : 156g

Color Option :



MTB Hub

HU-DM874-R

Pro 4 Flange PAT.

MTB

Holes : 28/32H

Axle : AL7075

O.L.D : M12-142mm

Bearing: 5 pcs

P.C.D : 62/57-61/56mm

Weight : 320 g

Shimano : Type 9/10/11/12 Speed

Optional: SRAM : XD / XDR

CAP M10-135mm



HU-DM874-F

Pro 4 Flange PAT.

MTB

Holes : 28/32 H

Axle : AL7075

O.L.D : M15-100mm

Bearing: 2 pcs

P.C.D : 62/57-61/56mm

Weight : 204 g

Optional: M9-100mm/M20-110mm



HU-DM834-R

Pro 4 Flange PAT.

MTB

Holes : 28/32H

Axle : AL7075

O.L.D : M12-142mm

Bearing: 4 pcs

P.C.D : 62/57-61/56mm

Weight : 316 g

Shimano : Micro Spline 12 Speed

CAP M10-135mm



Color Option :



MTB Hub



HU-DM874B-R (BOOST)

Pro 4 Flange PAT.

MTB

Holes : 28/32H

Axle : AL7075

O.L.D : M12-148mm

Bearing: 5 pcs

P.C.D : 62/57-61/56mm

Weight : 312 g

Shimano : Type 9/10/11/12 Speed

Optional: SRAM : XD / XDR



HU-DM874B-F (BOOST)

Pro 4 Flange PAT.

MTB

Holes : 28/32H

Axle : AL7075

O.L.D : M15-110mm

Bearing: 2 pcs

P.C.D : 62/57-61/56mm

Weight : 212 g

Optional: BOOST M20



HU-DM834B-R (BOOST)

Pro 4 Flange PAT.

MTB

Holes : 28/32H

Axle : AL7075

O.L.D : M12-148mm

Bearzzzzing: 4 pcs

P.C.D : 62/57-61/56mm

Weight : 326 g

Shimano : Micro Spline

Color Option :



MTB Hub

HU-DM873-R

MTB

Holes : 28/32H

Axle : AL7075

O.L.D : M12-142mm

Bearing: 4 pcs

P.C.D : 58/58mm

Weight : 290g

Shimano : Type 9/10/11/12 Speed

Optional: SRAM : XD / XDR

CAP- M10-135mm



HU-DM873-F

MTB

Holes : 28/32H

Axle : AL7075

O.L.D : M15-100mm

Bearing: 2 pcs

P.C.D : 58/58mm

Weight : 186g

Optional :M9-100mm/M20-110mm



HU-DM823-R

MTB

Holes : 28/32H

Axle : AL7075

O.L.D : M12-142mm

Bearing: 4 pcs

P.C.D : 58/58mm

Weight : 290g

Shimano : Micro Spline

Optional: M10-135mm



Color Option : 

MTB Hub



HU-DM873B-R (BOOST)

MTB

Holes : 28/32 H

Axle : AL7075

O.L.D : M12-148mm

Bearing: 4 pcs

P.C.D : 58/58mm

Weight : 290 g

Shimano : Type 9/10/11/12 Speed

Optional: SRAM : XD / XDR



HU-DM873B-F (BOOST)

MTB

Holes : 28/32H

Axle : AL7075

O.L.D : M15-110mm

Bearing: 2 pcs

P.C.D : 58/58mm

Weight : 196g

Optional: BOOST M20



HU-DM823B-R (BOOST)

MTB

Holes : 28/32 H

Axle : AL7075

O.L.D : M12-148mm

Bearing: 4 pcs

P.C.D : 58/58mm

Weight : 298 g

Shimano : Micro Spline

Color Option :



MTB Hub

HU-M653-R

MTB
Holes : 28/32/36H
Axle : CR-MO
O.L.D : M10-135mm
Bearing: 4 pcs
P.C.D : 58/58mm
Weight : 340g
Shimano : Type 9/10/11/12 Speed



HU-M653-F

MTB
Holes : 28/32/36H
Axle : CR-MO
O.L.D : M9-100mm
Bearing: 2 pcs
P.C.D: 58/58 mm
Weight : 196g



HU-M863-R

MTB
Holes : 28/32/36H
Axle : AL7075
O.L.D : M12-142mm (CAP-M10-135mm)
Bearing: 4 pcs
P.C.D : 58/58mm
Weight : 290 g
Shimano : Type 9/10 /11/12 Speed
Optional: SRAM : XD / XDR
CAP-M10-135mm



HU-M863-F

MTB
Holes : 28/32/36H
Axle : AL7075
O.L.D : M12-100mm(CAP-M9-100mm)
Bearing: 2 pcs
P.C.D: 58/58 mm
Weight : 172g
Optional : M9-100mm



Color Option : 

Racing X-Country Hub



HU-MR976-R

RACING X-Country

Holes : 24 H

Axle : AL7075

O.L.D : M12-142mm

Bearing: 4 pcs

P.C.D : 47/56mm

Weight : 268g

Shimano : Type 9/10/11/12 Speed

Optional: SRAM : XD / XDR

CAP-M10-135mm



HU-MR976-F

RACING X-Country

Holes : 20 H

Axle : AL7075

O.L.D : M12-100mm

Bearing: 2 pcs

P.C.D : 46.6/46.6 mm

Weight : 160g

Optional : M9-100mm



HU-MR978-R

RACING X-Country

Center Lock Disc Brake

Holes : 24 H

Axle : AL7075

O.L.D : M12-142mm

Bearing: 4 pcs

P.C.D : 47/56mm

Weight : 262g

Shimano : Type 9/10/11/12 Speed

Optional: SRAM : XD / XDR

CAP-M10-135mm



HU-MR978-F

RACING X-Country

Center Lock Disc Brake

Holes : 24 H

Axle : AL7075

O.L.D : M12-100mm

Bearing: 2 pcs

P.C.D : 46.6/46.6 mm

Weight : 158g

Optional : M9-100mm

Color Option :



Gravel Racing MTB Hub

HU-GR884-R

Pro 4 Flange PAT.

GRAVEL RACING MTB

Center Lock Disc Brake

Holes : 24/28H

Axle : AL7075

O.L.D : M12-142mm

Bearing: 5 pcs

P.C.D : 57/52-61/56mm

Weight : 286g

Shimano : Type 9/10/11/12 Speed

Optional: SRAM : XD / XDR

CAP-M10-135mm



HU-GR884-F

Pro 4 Flange PAT.

GRAVEL RACING MTB

Center Lock Disc Brake

Holes : 24/28 H

Axle : AL7075

O.L.D : M12-100mm

Bearing: 2 pcs

P.C.D : 57/52-50/45 mm

Weight : 158g

Optional : M9-100mm



HU-GR828-R

GRAVEL RACING MTB

Center Lock Disc Brake

Holes : 24/28H

Axle : AL7075

O.L.D : M12-100mm

Bearing: 4 pcs

P.C.D : 53/58 mm

Weight : 274g

Shimano : Type 9/10/11/12 Speed

Optional: SRAM : XD / XDR

CAP-M10-135mm



HU-GR828-F

GRAVEL RACING MTB

Center Lock Disc Brake

Holes : 24/28 H

Axle : AL7075

O.L.D : M12-100mm

Bearing: 2 pcs

P.C.D : 49/53 mm

Weight : 156g

Optional : M9-100mm



Color Option : 

Gravel Racing MTB Hub



HU-MR813-R

GRAVEL RACING MTB

Holes : 24/28/32 H

Axle : AL7075

O.L.D : M12-142mm

Bearing: 4 pcs

P.C.D : 58/58 mm

Weight : 288g

Shimano : Type 9/10/11/12 Speed

Optional: SRAM : XD / XDR

CAP-M10-135mm



HU-MR813-F

GRAVEL RACING MTB

Holes : 24/28/32 H

Axle : AL7075

O.L.D : M12-100mm

Bearing: 2 pcs

P.C.D : 58/49 mm

Weight : 170g

Optional :CAP- M9-100mm



HU-MR827SI-R

GRAVEL RACING MTB

Holes : 24/28/32 H

Axle : AL7075

O.L.D : M12-142mm (CAR-M10-135mm)

Bearing: 5 pcs

P.C.D : 58/60 mm

Weight : 510g

Shimano : Type 9/10/11/12 Speed

Optional: SRAM : XD / XDR

CAP-M10-135mm

Silent Less rotational resistance

Color Option :



Racing Hub

HU-R923-R

RACING
 V- Brake
 Holes : 24 H
 Axle : AL7075
 O.L.D : M10-130mm
 Bearing: 4 pcs
 P.C.D : 36/64mm
 Weight : 232g
 Shimano : Type 9/10/11 Speed
 Optional: SRAM / XDR

HU-R923-F

RACING
 V- Brake
 Holes : 20 H
 Axle : AL7075
 O.L.D : M9-100mm
 Bearing: 2 pcs
 P.C.D : 36/36 mm
 Weight : 94 g



HU-R683-R

RACING
 V- Brake
 Holes : 24 H
 Axle : AL7075
 O.L.D : M10-130mm
 Bearing: 4 pcs
 P.C.D : 44/58mm
 Weight : 232g
 Shimano : Type 9/10/11 Speed
 Optional: SRAM / XDR

HU-R683-F

RACING
 V- Brake
 Holes : 20 H
 Axle : AL7075 T6
 O.L.D : M9-100mm
 Bearing: 2 pcs
 P.C.D : 44/44 mm
 Weight : 92 g



HU-R687SI-R

RACING
 V- Brake
 Holes : 24 H
 Axle : AL7075
 O.L.D : M10-130mm
 Bearing: 5 pcs
 P.C.D : 44/60mm
 Weight : 410 g
 Shimano : Type 9/10/11 Speed
 Optional: SRAM / XDR
 Silent Less rotational resistance



Color Option : 

BMX Hub



HU-B866-R

BMX
V- Brake
Holes : 36 H
Axle : AL7075 T6
O.L.D : M14-110mm
Bearing: 4 pcs
P.C.D : 46/58mm
Weight : 450g
Available with 9T driver/CR-MO



HU-B896-R

BMX
V- Brake
Holes : 36 H
Axle : AL7075 T6
O.L.D : 3/8-110mm
Bearing: 4 pcs
P.C.D : 46/58mm
Weight : 354g
Note Driver in alloy material



HU-B897SI-R

BMX
V- Brake
Holes : 36 H
Axle : AL7075 T6
O.L.D : 3/8-110mm
Bearing: 6 pcs
P.C.D : 46/60mm
Weight : 530g
Note Driver in alloy material
Silent Less rotational resistance

Color Option :



Snow/Fat Bike Hub

HU-FT854S-R

Pro 4 Flange PAT.

SNOW/FAT BIKE

Holes : 28/32 H

Axle : AL7075

O.L.D : M12-177 mm

Bearing: 5 pcs

P.C.D : 62/57-61/56 mm

Weight : 346 g

Shimano : Type 9/10/11/12 Speed

Optional: SRAM : XD / XDR



HU-FT854S-F

Pro 4 Flange PAT.

SNOW/FAT BIKE

Holes : 28/32 H

Axle : AL7075

O.L.D : M15-135 mm

Bearing: 2 pcs

P.C.D : 62/57-61/56 mm

Weight : 242 g



HU-FT854-R

Pro 4 Flange PAT.

SNOW/FAT BIKE

Holes : 28/32 H

Axle : AL7075

O.L.D : M12-197 mm

Bearing: 5 pcs

P.C.D : 62/57-61/56 mm

Weight : 362 g

Shimano : Type 9/10/11/12 Speed

Optional: SRAM : XD / XDR



HU-FT854-F

Pro 4 Flange PAT.

SNOW/FAT BIKE

Holes : 28/32 H

Axle : AL7075

O.L.D : M15-150mm

Bearing: 2 pcs

P.C.D : 62/57-61/56 mm

Weight : 258 g



Color Option :



Snow/Fat Bike Hub



HU-FT894-R

Pro 4 Flange PAT.

SNOW/FAT BIKE

Center Lock Disc Brake

Holes : 28/32 H

Axle : AL7075

O.L.D : M12-197 mm

Bearing: 5 pcs

P.C.D : 57/52-61/56 mm

Weight : 346 g

Shimano : Type 9/10/11/12 Speed

Optional: SRAM : XD / XDR



HU-FT894-F

Pro 4 Flange PAT.

SNOW/FAT BIKE

Center Lock Disc Brake

Holes : 28/32 H

Axle : AL7075

O.L.D : M12-150 mm

Bearing: 2 pcs

P.C.D : 57/52-50/45 mm

Weight : 206 g



HU-DM874L-R

Pro 4 Flange PAT.

MTB DH

Holes : 28/32 H

Axle : AL7075

O.L.D : M12-157 mm

Bearing: 5 pcs

P.C.D : 62/57-61/56 mm

Weight : 326 g

Shimano : Type 9/10/11/12 Speed

Optional: SRAM : XD / XDR

Color Option :



Wheel Set



Wheel Set

Quadpro 4 Flange PAT.

WH-EB2932 (Boost)

MTB E-BIKES 29" (Tubeless Ready)

RIM: 29"*1.25-2.5(622) ERD.587.5

Disc Brake 32H

FRONT: O.L.D.M15-110mm

REAR : O.L.D.M12-148mm

CASSETTE: Shimano 9/10/11/12 Speed

OPTION: Sram/XD

Weight: 2370 g / pair

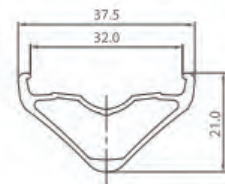

WH-EB793 (Boost)

MTB E-BIKES 29"

RIM: 29"*1.25-2.5(622) ERD.605

Disc Brake 36H

FRONT: O.L.D.M15-110mm

REAR : O.L.D.M12-148mm

CASSETTE: Shimano 9/10/11/12 Speed

OPTION: Sram/XD

Weight: 2290 g / pair

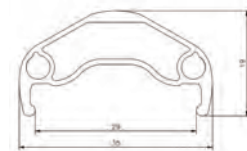

Quadpro 4 Flange PAT.

WH-EGR7925

ROAD E-BIKES 700C (Tubeless Ready)

RIM: 700C*25-35C(622) ERD.570.5

Center Lock Disc Brake 28H

FRONT: O.L.D.M12-100mm

REAR : O.L.D.M12-142mm

CASSETTE: Shimano 9/10/11/12 Speed

OPTION: Sram/XDR

Weight: 2070g / pair

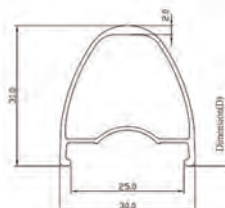

Wheel Set

Quadpro 4 Flange PAT. WH-DM2930 (Boost)

MTB 29" (Tubeless Ready)

RIM: 29"*1.25-2.5(622) ERD.587.5

Disc Brake 32H

FRONT: O.L.D.M15-110mm

REAR : O.L.D.M12-148mm

CASSETTE: Shimano 9/10/11/12 Speed

OPTION: Sram/XD

Weight: 2155g / pair

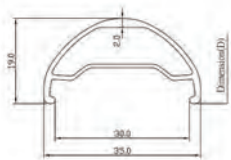

Quadpro 4 Flange PAT. WH-ML8730 (Boost)

MTB-LINDAU (Tubeless Ready)

RIM: 29"*1.25-2.5(622) ERD.604mm

Disc Brake 28H

FRONT: O.L.D.M12-110mm

REAR : O.L.D.M12-148mm

CASSETTE: Shimano 9/10/11/12 Speed

OPTION: Sram/XDR

Weight: 2030 g / pair

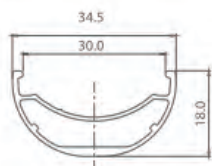

Quadpro 4 Flange PAT.

WH-GR9749 (Tubeless Ready)

GRAVEL 700C (Tubeless Ready) CARBON 50mm

RIM: 700C*25-45C(622) ERD.538

Center Lock Disc Brake 28H

FRONT: O.L.D.M12-100mm

REAR : O.L.D.M12-142mm

CASSETTE: Shimano 9/10/11/12 Speed

OPTION: Sram/XDR

Weight: 1660 g / pair

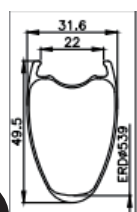

Wheel Set



Quadpro 4 Flange PAT. WH-GM8925

GRAVEL 700C (Tubeless Ready)

WH-GM7925

RIM: 700C/29"*1.5-2.215(622) ERD.587.5

Center Lock Disc Brake 28H

FRONT: O.L.D.M12-100mm

REAR : O.L.D.M12-142mm

CASSETTE: Shimano 9/10/11/12 Speed

OPTION: Sram/XDR

Weight: 1670 g / pair

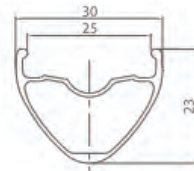

Quadpro 4 Flange PAT. WH-RD9719 (CARBON)

ROAD 700C (Tubeless Ready) CARBON 50mm

RIM: 700C*23C-28C(622) ERD.539

Center Lock Disc Brake 24H

FRONT: O.L.D.M12-100mm

REAR : O.L.D.M12-142mm

CASSETTE: Shimano 9/10/11/12 Speed

OPTION: Sram/XDR

Weight: 1650 g / pair

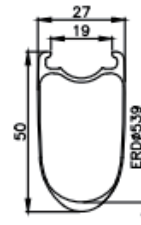

Quadpro 4 Flange PAT. WH-RD7021

ROAD 700C (Tubeless Ready)

RIM: 700C*23C-28C(622) ERD.587.5

Center Lock Disc Brake 24H

FRONT: O.L.D.M12-100mm

REAR : O.L.D.M12-142mm

CASSETTE: Shimano 9/10/11/12 Speed

OPTION: Sram/XDR

Weight: 1650 g / pair

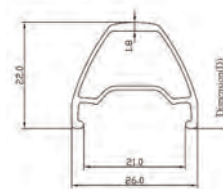

Rim

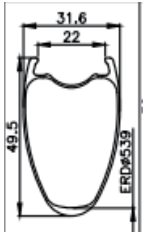

RI-R750CA (Tubeless Ready)

RACING
Disc Brake
Diameter : 700C
Spoke : 24H
ETRTO : 622mm
ERD : 539mm
Material : CARBON
Weight : 470g

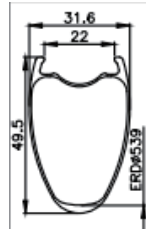

RI-GM749CA (Tubeless Ready)

GRAVEL/MTB
Disc Brake
Diameter : 700C
Spoke : 28H
ETRTO : 622mm
ERD : 539mm
Material : CARBON
Weight : 460g

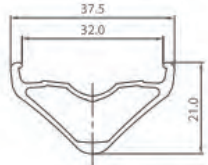

RI-EB932 (Tubeless Ready)

E-BIKE
Disc Brake
Diameter : 650B/29er
Spoke : 32H/36H
Weight : 615g(650B) 650g(29er)
ETRTO : 584.1mm(650B)622mm(29er)
ERD : 558mm(650B)595.5mm(29er)
Material : AL6069

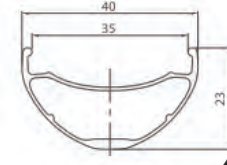

RI-M935 (Tubeless Ready)

MTB
Disc Brake
Diameter : 650B/29er
Spoke : 28H/32H
Weight : 540g(650B) 575g(29er)
ETRTO : 584.1mm(650B)622mm(29er)
ERD : 554.5mm(650B)590mm(29er)
Material : AL6066

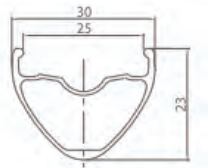

RI-GM925 (Tubeless Ready)

GRAVEL/MTB
Disc Brake
Diameter : 650B/29er
Spoke : 28H/32H
Weight : 420g(650B) 440(29er)
ETRTO : 584.1mm(650B)622mm(29er)
ERD : 556.9mm(650B)594.3mm(29er)
Material : AL6069

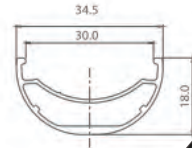

RI-M930 (Tubeless Ready)

MTB
Disc Brake
Diameter : 650B/29er
Spoke : 28H/32H
Weight : 465g(650B) 495g(29er)
ETRTO : 584.1mm(650B)622mm(29er)
ERD : 566.5mm(650B)604mm(29er)
Material : AL6069

Frame



Frame



FRAME 700C GRAVEL / 29" CROSS FR-GR709

Headset : 1-1/8*1.5" (41.8*45°/45°-51.8*45°*45°)

Material : AL7005 Triple Tubbed

Size : 43/46/49/52/55/58CM

Weight : 1470 g / 46 cm

FORK FK-GR709

Material : Carbon

Steerer : 28.6mm

Crown : 1-1/8 - 1.5"

Weight : 420 g

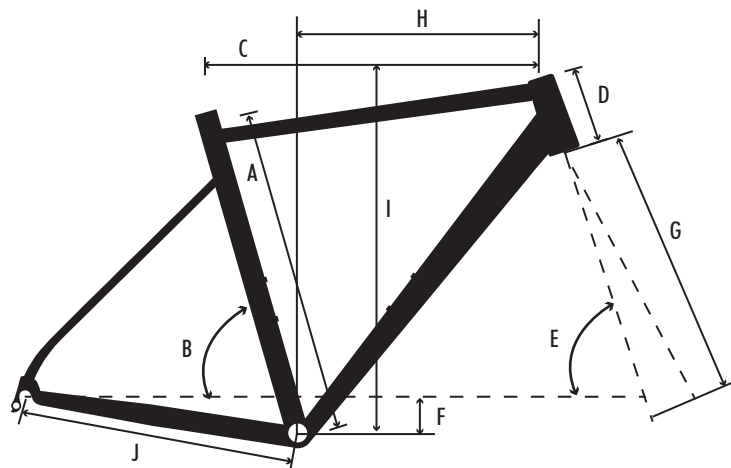

	XS	S	M	L	XL	2L
A.....SEAT TUBE	430	460	490	520	550	580
B.....SEAT ANGLE	74	74	74	74	74	74
C.....TOP TUBE	505.7	515.3	525	535.9	550.2	565
D.....HEAD TUBE	120	125	130	140	155	170
E.....HEAD ANGLE	70.5	70.5	70.5	71.5	71.5	71.5
F.....BB DROP	65	65	65	65	65	65
G.....FORK LENGTH	397	397	397	397	397	397
H.....REACH	351	360	368	375	385	396
I.....STACK	538	543	548	561	575	589
J.....CHAINSTAY	430	430	430	430	430	430
TIRES MAXIMUM 700C	45C	45C	45C	45C	45C	45C
TIRES MAXIMUM 29"	1.75	1.75	1.75	1.75	1.75	1.75

Frame



FRAME 700C GRAVEL / 29" CROSS FR-GR970

Headset: 1-1/8*1.5" (41.8*45°/45°-51.8*45°*45°)

Material: Carbon

Size: 50/53/55/57/59 cm

Weight: 1100 g

FORK FK-GR709

Material: Carbon

Steerer: 28.6mm

Crown: 1-1/8 - 1.5"

Weight: 420 g

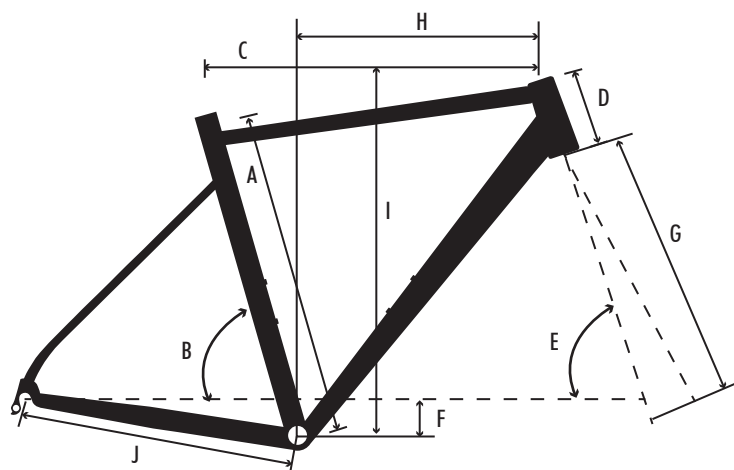

	S	M	L	XL	2L
A.....SEAT TUBE	500	530	550	570	590
B.....SEAT ANGLE	73.5	73.5	73.5	73.5	73.5
C.....TOP TUBE	525	540	560	580	600
D.....HEAD TUBE	115	130	150	170	190
E.....HEAD ANGLE	71	71.5	72	72.5	72.5
F.....BB DROP	70	70	70	70	70
G.....FORK LENGTH	395	395	395	395	395
H.....REACH	365.6	376.5	390.3	404.1	417.8
I.....STACK	535.9	552	572.9	593.8	612.9
J.....CHAINSTAY	435	435	435	435	435
TIRES MAXIMUM 700C	45C	45C	45C	45C	45C
TIRES MAXIMUM 29"	1.75	1.75	1.75	1.75	1.75

Handlebar



Handlebar MTB



HB-M8135

Material: AL7075 T6
Thickness: Butted
Clamp: 35.0mm
Rise : 25 mm
Width : 780 mm
Weight: 290 g



HB-M7131

Material: AL6061 T6
Thickness: Butted
Clamp: 31.8mm
Rise : 25 mm
Width : 780 mm
Weight: 320 g



HB-M6318

Material: AL6061 T6
Thickness: 2.0T -2-0B
Clamp: 31.8mm
Rise : 30 mm
Width : 800 mm
Weight: 470 g



HB-M6335

Material: AL6061 T6
Thickness: 2.0T -2-0B
Clamp: 35.0mm
Rise : 30 mm
Width : 800 mm
Weight: 530 g

Handlebar MTB

HB-T155

Material: AL7075 T6
Thickness: Butted
Clamp: 31.8mm
Back Sweep : 12°
Width : 720 mm
Weight: 265 g



HB-M6323-0

Material: AL6061 T6
Thickness: 2.0T
Clamp: 31.8mm
Back Sweep : 0°
Width : 760 mm
Weight: 358 g



HB-M6323-5

Material: AL6061 T6
Thickness: 2.0T
Clamp: 31.8mm
Back Sweep : 5°
Width : 760 mm
Weight: 362 g



HB-M6323-12

Material: AL6061 T6
Thickness: 2.0T
Clamp: 31.8mm
Back Sweep : 12°
Width : 760 mm
Weight: 356 g



Handlebar Road



HB-R8300

Material: AL7075 T6
Thickness: Butted
Clamp: 31.8mm
Width : 400/420/440 mm
Weight: 238 g



HB-R8310

Material: AL7075 T6
Thickness: Butted
Clamp: 31.8mm
Width : 400/420/440 mm
Weight: 240 g



HB-R6508

Material: AL6061 T6
Thickness: Butted
Clamp: 31.8mm
Width : 400/420/440 mm
Weight: 270 g



HB-GR7325

Material: AL6061 T6
Thickness: Butted
Clamp: 31.8mm
Back Sweep : 12° / 25°
Width : 420/440/460 mm
Weight: 300 g

Stem



Stem

ST-MR211

Material: AL6061 T6 3D Forged
Bar Bord: 31.8 mm
Diameter: 28.6 mm
Extesion: 50/60/80/90/100/110/120 mm
Angle : $\pm 10^\circ$
Weight: 146 g



ST-GR317

Material: AL6061 T6 3D Forged
Bar Bord: 31.8 mm
Diameter: 28.6 mm
Extesion: 80/90/100/110/120 mm
Angle : $\pm 17^\circ$
Weight: 158 g

ST-M6318

Material: AL6061 T6 3D Forged
Bar Bord: 31.8 mm
Diameter: 28.6 mm
Extesion: 60/80/90/100 mm
Angle : $\pm 7^\circ$
Weight: 174 g



ST-M6335

Material: AL6061 T6 3D Forged
Bar Bord: 35.0 mm
Diameter: 28.6 mm
Extesion: 60 mm
Angle : $\pm 7^\circ$
Weight: 184 g

Stem

ST-M8230

Material: AL6061 T6 3D CNC
Bar Bord: 31.8 mm
Diameter: 28.6 mm
Extesion: 55/75 mm
Angle : 100°
Weight: 185 g



ST-M8135

Material: AL6061 T6 3D CNC
Bar Bord: 35.0 mm
Diameter: 28.6 mm
Extesion: 40 mm
Angle : 0°
Weight: 150 g



ST-M8318

Material: AL6061 T6 3D CNC
Bar Bord: 31.8 mm
Diameter: 28.6 mm
Extesion: 40 mm
Angle : 0°
Weight: 158 g



Seat Post



Seat Post



SP-M7120

Material: AL7075 T6 3D Forged
Diameter: 27.2/31.6mm
Offset: 5 mm
Length: 370mm
Weight: 230 g



SP-R7180

Material: AL7075 T6 3D Forged
Diameter: 27.2/31.6mm
Offset: 5 mm
Length: 300mm
Weight: 210 g



SP-M6310

Material: AL6061 T6 3D Forged
Diameter: 27.2/31.6mm
Offset: 0 mm
Length: 400mm
Weight: 316 g



SP-M6231

Material: AL6061 T6 3D Forged
Diameter: 27.2/30.9/31.6mm
Offset: 5 mm
Length: 370mm
Weight: 274 g



Headset



Headset

HS-H4656

For tapered 46mm/56mm OD head tube

For 1-1/8" to 1.5" tapered fork

AL6061 T6 fiber top cover

Upper: Campy Angular Contact Bearing (Black seal)

Lower: 1.5" 45°/45° Angular Contact Bearing (Black seal)

AL7075 T6 Crown Race

1-1/8" x 42 x 52.2 x 39.8

41.8 x 45° x 45° ACB Upper

52 x 45° x 45° ACB Lower



HS-H4656-S

For tapered 46mm/56mm OD head tube

For 1-1/8" to 1.5" tapered fork

AL6061 T6 fiber top cover

Upper: Campy Angular Contact Bearing (Black seal)

Lower: 1.5" 45°/45° Angular Contact Bearing (Black seal)

AL7075 T6 Crown Race

1-1/8" x 42 x 52.1 x 39.8

41.8 x 45° x 45° ACB Upper

51.8 x 45° x 45° ACB Lower



HS-H4856-S

For tapered 48mm/56mm OD head tube

For 1-1/8" to 1.5" tapered fork

AL6061 T6 fiber top cover

Upper: Campy Angular Contact Bearing (Black seal)

Lower: 1.5" 45°/45° Angular Contact Bearing (Black seal)

AL7075 T6 Crown Race

1-1/8" x 42 x 52.1 x 39.8

41.8 x 45° x 45° ACB Upper

51.8 x 45° x 45° ACB Lower



Headset

HS-H4651

For tapered 46mm/56mm OD head tube
For 1-1/8" to 1-1/4" tapered fork
AL6061 T6 fiber top cover
Upper: Campy Angular Contact Bearing (Black seal)
Lower: 1-1/4" 45°/45° Angular Contact Bearing (Black seal)
AL7075 T6 Crown Race



1-1/8" x 42 x 47.2 x 33
41.8 x 45° x 45° ACB Upper
47 x 45° x 45° ACB Lower



HS-H4252-S

For tapered 46mm/56mm OD head tube
For 1-1/8" to 1-1/4" tapered fork
AL6061 T6 fiber top cover
Upper: Campy Angular Contact Bearing (Black seal)
Lower: 1.1/4" 45°/45° Angular Contact Bearing (Black seal)
AL7075 T6 Crown Race



1-1/8" x 42 x 52 x 33
41.8 x 45° x 45° ACB Upper
46.9 x 45° x 45° ACB Lower



HS-H4642-S

For tapered 46mm OD head tube
For 1-1/8" steer
AL6061 T6 fiber top cover
Upper: Campy Angular Contact Bearing (Black seal)
Lower: 1.1/4" 45°/45° Angular Contact Bearing (Black seal)
AL7075 T6 Crown Race



1-1/8" x 42 x 42 x 30
41.8 x 45° x 45° ACB Upper
41.8 x 45° x 45° ACB Lower



Headset

HS-H4647

For tapered 46mm OD head tube

For 1-1/8" Steerer

AL6061 T6 fiber top cover

Upper: Campy Angular Contact Bearing (Black seal)

Lower: 1-1/8" 45°/45° Angular Contact Bearing (Black seal)

AL7075 T6 Crown Race

1-1/8" x 41.2 x 41.2 x 30

41 x 45° x 45° ACB Upper

41 x 45° x 45° ACB Lower



HS-H4541-S

For tapered 45mm OD head tube

For 1-1/8" steerer

AL6061 T6 fiber top cover

Upper: Campy Angular Contact Bearing (Black seal)

Lower: 1-1/8" 36°/45° Angular Contact Bearing (Black seal)

AL7075 T6 Crown Race

1-1/8" x 41.2 x 41.2 x 30

41 x 36° x 45° ACB Upper

41 x 36° x 45° ACB Lower



HS-4428

Head tube I.D. = 44mm O.D. = 50mm

For 1-1/8" steerer

AL6061 T6 fiber top cover

Upper: Campy Angular Contact Bearing (Black seal)

Lower: 1-1/8" 36°/45° Angular Contact Bearing (Black seal)

AL7075 T6 Crown Race

1-1/8" x 44 x 50 x 30

41 x 36° x 45° ACB Upper

41 x 36° x 45° ACB Lower



Headset

HS-H4415

Head tube I.D. = 44mm O.D. = 50mm

For 1-1/8" to 1.5" tapered fork

AL6061 T6 fiber top cover

Upper: 41x36°/45° Cartridge ball bearings

Lower: 51.8/45°/45° Cartridge ball bearings

AL7075 T6 Crown Race

1-1/8" x 44 x 44 x 39.8

41 x 36° x 45° ACB Upper

51.8 x 45° x 45° ACB Lower



HS-4455

Head tube I.D. = 44mm O.D. = 50mm / I.D. = 55mm O.D. = 61mm

For 1-1/8" to 1.5" tapered fork

AL6061 T6 fiber top cover

Upper: 41x36°/45° Cartridge ball bearings

Lower: 51.8/45°/45° Cartridge ball bearings

AL7075 T6 Crown Race

1-1/8" x 44 x 55 x 39.8

41 x 36° x 45° ACB Upper

51.8 x 45° x 45° ACB Lower



HS-4456

Head tube I.D. = 44mm O.D. = 50mm / I.D. = 56mm O.D. = 61mm

For 1-1/8" to 1.5" tapered fork

AL6061 T6 fiber top cover

Upper: 41x36°/45° Cartridge ball bearings

Lower: 51.8/45°/45° Cartridge ball bearings

AL7075 T6 Crown Race

1-1/8" x 44 x 56 x 39.6

41 x 36° x 45° ACB Upper

51.8 x 45° x 45° ACB Lower



HS-3428

Head tube I.D. = 34mm O.D. = 40mm

For 1-1/8" tapered steerer

AL6061 T6 fiber top cover

Upper: Campy Angular Contact Bearing (Black seal)

Lower: 1-1/8" 36°/45° Angular Contact Bearing (Black seal)

AL7075 T6 Crown Race

1-1/8" x 34 x 34 x 30

41 x 36° x 45° ACB Upper

41 x 36° x 45° ACB Lower



Parts



Ahead Cap



RS-3228
Material:AL6061 CNC
Bolt : Stainless
Size : 1-1/8"
Weight : 26 g



RS-3227
Material:AL6061 CNC
Bolt : AL2014
Size : 1-1/8"
Weight : 18 g



RS-3318
Material:AL6061
Bolt : Stainless
Size : 1-1/8"
Weight : 22 g



RS-3319
Material:AL6061
Bolt : Stainless
Size : 1-1/8"
Weight : 22 g



RS-AirTag
Material:AL6061 CNC
Bolt : Stainless
Size : 1-1/8"
Weight : 34 g



RS-50CA
Material:AL6061 CNC
Bolt : AL2014/ Stainless
Length : 50 mm
Size : 1-1/8"
Weight : 50 g



RS-2310
Material:AL6061 CNC
Bolt : AL2014
Length : 210-270mm
Size : 1-1/8"
Weight : 50 g



RS-1515
Material:AL6061 CNC
Bolt : AL2014
Length : 210-270mm
Size : 1.5"/1.5"
Weight : 85 g



RS-2315
Material:AL6061 CNC
Bolt : AL2014
Length : 210-270mm
Size : 1-1/8" / 1.5"
Weight : 72 g

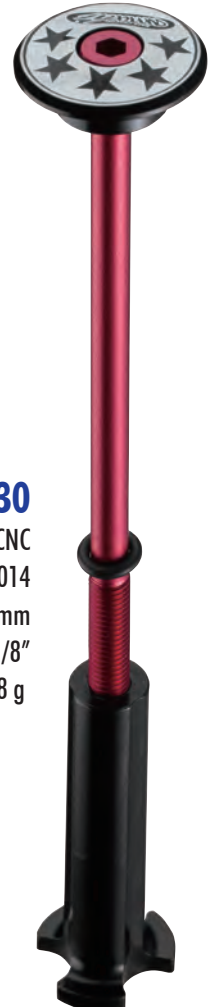

RS-2330
Material:AL6061 CNC
Bolt : AL2014
Length : 210-270mm
Size : 1-1/8"
Weight : 58 g

Parts

QR-M142R MTB

Material: AL7075 T6
HUB-Rear: M12-P1.5/P1.75
Length: 174mm



QR-M148R MTB

Material: AL7075 T6
HUB-Rear: M12-P1.5/P1.75
Length: 184mm



QR-R142R ROAD

Material: AL7075 T6
HUB-Rear: M12-P1.5
Length: 162mm



QR-R100 FORK (CARBON) Racing

Material: AL7075 T6
HUB-Rear: M12-P1.5
Length: 123mm



QR-4

Material: CR-MO axle
MTB (F): M5-100mm. (R): M5-135mm
ROAD (F): M5-100mm. (R): M5-130mm



CL-1P

Seat Clamp
Material: AL6061 Forged
Diameter: 28.6/29.8/31.8/34.9 mm



CL-1

Seat Clamp
Material: AL6061 Forged
Diameter: 28.6/29.8/31.8/34.9 mm



CL-FD7

Front Derailleur Clamp
Material: AL6061
Diameter: 28.6/31.8/34.9 mm

Parts

PE-M213

Body:AL6061 Forged
Axle:Cr-Mo
Weight: 260 g/set

Upgrade
the power
of your
pedaling.

PAT.M409220



Reduce
the friction
of
disharmony.



PE-T5

Pedal Adoper
Body:AL6061 Forged
Weight: 260 g/set



Parts



JY-880

Material:AL6061
One-Piece construction



JY-875

Material:AL6061
One-Piece construction



JY-T3

Material:AL6061
Handlebar Grip Stopper



SH-HB1

Material:AL6061
O.D:31.8mm
I.D: 25.4mm
Length: 50 mm



SH-SP1

Material:AL6061
O.D:31.6mm
I.D: 27.2mm
Length: 75 mm

JY-WA5

Material:AL6061
Diameter: 28.6mm
Height: 5/10/15 mm



Parts



S-W1
Material:AL6061

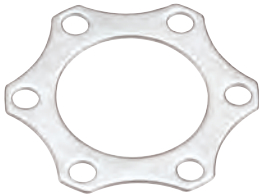

HUB-CL6 SET
6 Center Lock Disc Brake
Material: AL6061 CNC



X-W6
Material:Carbon



JY-R1
Material:AL6061
Seatpost Diameter:25.4-31.8mm



GR-2
125mm
2 Density
Double side lock



GR-120
130mm
2 Density
Double side lock



GR-145
145mm
2 Density
Double side lock



FM-PM160F
Convert fork flat mount to post mount with 160mm rotor



FM-PM160R
Convert frame flat mount to post mount with 160mm rotor